

Addressing reliability requirements in Zetland and Waterloo load areas

DRAFT PROJECT ASSESSMENT REPORT

21 October 2022

Disclaimer

Ausgrid is registered as both a Distribution Network Service Provider and a Transmission Network Service Provider. This Draft Project Assessment Report has been prepared and published by Ausgrid under clause 5.17 of the National Electricity Rules to notify Registered Participants and Interested Parties of the results of the regulatory investment test for distribution and should only be used for those purposes.

This document does not purport to contain all of the information that a prospective investor or participant or potential participant in the National Electricity Market, or any other person or interested parties may require. In preparing this document it is not possible nor is it intended for Ausgrid to have regard to the investment objectives, financial situation and particular needs of each person who reads or uses this document.

This document, and the information it contains, may change as new information becomes available or if circumstances change. Anyone proposing to rely on or use the information in this document should independently verify and check the accuracy, completeness, reliability and suitability of that information for their own purposes.

Accordingly, Ausgrid makes no representations or warranty as to the accuracy, reliability, completeness or suitability for particular purposes of the information in this document. Persons reading or utilising this document acknowledge that Ausgrid and their employees, agents and consultants shall have no liability (including liability to any person by reason of negligence or negligent misstatement) for any statements, opinions, information or matters (expressed or implied) arising out of, contained in or derived from, or for any omissions from, the information contained in this document, except insofar as liability raised under New South Wales and Commonwealth legislation.

Addressing reliability requirements in Zetland and Waterloo load areas

Draft Project Assessment Report – October 2022

Contents

DISCLAIMER	1
EXECUTIVE SUMMARY	3
1 INTRODUCTION	7
1.1 Role of this draft report	7
1.2 Submissions and queries.....	8
2 DESCRIPTION OF THE IDENTIFIED NEED	9
2.1 Overview of the Eastern Suburbs subtransmission network and existing supply arrangements for the Eastern Suburbs load area.....	9
2.2 Summary of the ‘identified need’.....	10
2.3 Key assumptions underpinning the identified need.....	10
3 THREE CREDIBLE OPTIONS HAVE BEEN ASSESSED.....	13
3.1 Option 1 – Replace the SCFF feeders like-for-like (modern equivalent asset)	13
3.2 Option 2 – Replace SCFF sections of feeders 9SA and 92P, loop Zetland ZS into feeder 92P and close Zetland 132kV busbar.....	14
3.3 Option 3 – Replace SCFF sections of feeders 9SA and 92P, loop Zetland ZS into feeder 92P and defer works on closing Zetland 132kV busbar	15
3.4 Options considered but not progressed	16
4 HOW THE OPTIONS HAVE BEEN ASSESSED.....	17
4.1 General overview of the assessment framework	17
4.2 Ausgrid’s approach to estimating project costs.....	17
4.3 Market benefits are expected from reduced involuntary load shedding	18
4.4 Three different ‘scenarios’ have been modelled to address uncertainty	19
5 ASSESSMENT OF THE CREDIBLE OPTIONS.....	20
5.1 Gross market benefits estimated for the credible options	20
5.2 Estimated costs for the credible options	20
5.3 Net present value assessment outcomes	21
5.4 Sensitivity analysis results	21
6 PROPOSED PREFERRED OPTION AND COMMUNITY CONSULTATION.....	25
6.1 Community consultation	25
APPENDIX A – CHECKLIST OF COMPLIANCE CLAUSES.....	26
D.1 Characteric load duration curve	29
D.2 Supply restoration assumptions.....	30
D.3 Probability of failure	30
D.4 Environmental costs	32
D.5 Direct costs of rquipment failures.....	33
D.6 Calculation of central VCR estimate for Zetland ZS.....	33

Executive Summary

This report represents the application of the RIT-D to options for replacing ageing fluid-filled feeders to meet reliability requirements in Zetland and Waterloo load areas

This Draft Project Assessment Report (**DPAR**) has been prepared by Ausgrid and represents the second step in the application of the Regulatory Investment Test for Distribution (**RIT-D**), following publication of the Options Screening Notice with regard to options for replacing aging fluid-filled feeders in the Zetland and Waterloo load areas.

The underground electricity subtransmission cables ('feeders') supplying the Eastern Suburbs load area include self-contained fluid filled (**SCFF**) feeders, which are now considered an obsolete and outdated technology. They are becoming less reliable and approaching the point at which their replacement maximises the net benefit for the community. Ausgrid has made a commitment to the NSW Environment Protection Authority (**EPA**) to a program of replacing or retiring all SCFF cables with known leaks by 2034, due to the environmental risks associated with oil leaking from these cables (as well as the associated decline in network reliability).

Feeders 260, 261, 9SA and 92P (which supply the Zetland and Waterloo load areas as well as some portions of the Eastern Suburbs load area) are all ranked in the group of SCFF feeders to be replaced or retired as a priority, being high or medium risk feeders.

Ausgrid has identified the need to mitigate risks associated with 132kV feeders 260 and 261, which run from Beaconsfield Supply Point (**BSP**) to Zetland Zone Substation (**ZS**). If action is not taken, planning studies indicate that there will be substantial unserved energy to loads in this area of the network if these cables fail, as well as significant reactive maintenance costs associated with having to repair and restore service, and environmental risks from oil leaking from the cables. Without action it is expected that Ausgrid's electricity distribution license reliability and performance standards will be breached.

Ausgrid has also identified 132kV feeders 9SA and 92P as a high priority for replacement with modern technology cables, because of the environmental risks associated with potential oil leaks from these cables. Feeders 9SA and 92P run from the Beaconsfield BSP to Campbell St ZS and Belmore Park ZS respectively. They are key feeders that form part of Sydney's Inner Metropolitan Subtransmission network. Due to their geographic proximity, addressing concerns associated with feeders 9SA and 92P at the same time as replacing feeders 260 and 261 offers cost efficiencies when compared to addressing them in isolation.

Ausgrid is therefore undertaking a **RIT-D** to assess options for addressing the risk that the existing ageing SCFF feeders 260, 261, 9SA and 92P pose and to ensure we continue to satisfy our reliability and performance standards. This DPAR represents the second step in the application of the RIT-D to options for ensuring reliable electricity supply to the Eastern Suburbs load area and follows publication of the Options Screening Notice.

The 'identified need' for this RIT-D is to maintain the required level of reliability for customers in Zetland and Waterloo load areas

Ausgrid is obliged to comply with reliability and performance standards as part of its distribution license granted by the Minister for Industry, Resources and Energy under the *Electricity Supply Act 1995 (NSW)*. Under Ausgrid's license, reliability and performance standards are expressed in two measures:

- SAIDI¹ – which means the average derived from the sum of the durations of each sustained customer interruption (measured in minutes), divided by the total number of customers (averaged over the financial year); and
- SAIFI² – which means the average derived from the total number of sustained customer interruptions divided by the total number of customers (averaged over the financial year).

These two reliability measures capture two key sources of inconvenience to electricity customers from supply disruptions, i.e. how long their electricity supply is off for as well as how often their electricity supply is off. Customers experience less

¹ System Average Interruption Duration Index.

² System Average Interruption Frequency Index.

inconvenience (i.e. a better level of supply reliability), the lower each of these measures are. Reliability standards applied to distribution networks typically set maximums in relation to each of these two measures.

As noted above, Ausgrid’s analysis shows that if action is not taken to replace feeders 260 and, 261, the unserved energy under certain contingencies will be substantial in addition to the increasing reactive maintenance costs associated with having to repair and restore service and environmental risks from oil leaks. Ausgrid therefore considers that a network solution is required to mitigate the identified risks.

In addition, Ausgrid has made a commitment to the NSW Environment Protection Authority (EPA) to a program of replacing or retiring all SCFF cables with known leaks by 2034, due to the environmental risks associated with oil leaking from these cables (as well as the associated decline in network reliability). Of Ausgrid’s remaining SCFF cables, feeders 9SA and 92P are at the high end of environment risks, while feeders 260 and 261 are in the middle of the range. Due to their geographic proximity, addressing concerns associated with feeders 9SA and 92P at the same time as replacing feeders 260 and 261 offers cost efficiencies when compared to addressing them in isolation.

Three network options have been identified and assessed

Ausgrid has identified and assessed three different network options as part of this DPAR.

Table E1 – Credible network options assessed, \$2021/22

Option	Capital cost	Commissioning
Option 1 – Replace the existing feeders 9SA, 92P, 260 and 261 like-for-like using modern equivalent technology	\$52.2 million	2025/26
Option 2 – Replace SCFF sections of feeders 9SA and 9SP, loop Zetland ZS into feeder 92P and close Zetland 132kV busbar	\$40.7 million	2029/30
Option 3 – Replace SCFF sections of feeders 9SA and 92P, loop Zetland ZS into feeder 92P and defer works on closing Zetland 132kV busbar	\$37.1 million	2025/26

Non-network options and stand-alone power systems are not deemed viable for this RIT-D

Ausgrid has considered the ability of any non-network or stand-alone power system (SAPS) solutions to assist in meeting the identified need. An assessment into reducing the risk of unserved energy has shown that these alternatives are unlikely to cost-effectively address the risk, compared to the network options outlined above. This result is driven primarily by the significant amount of unserved energy that each network option allows to be avoided, compared to the base case, and the cost of non-network or SAPS solutions. This is detailed further in the separate Options Screening Notice released in accordance with clause 5.17.4(d) of the NER.

Three different ‘scenarios’ have been modelled to deal with uncertainty

Ausgrid has assessed three alternative future scenarios for this RIT-D – namely a:

- low benefit scenario – Ausgrid has adopted a number of assumptions that give rise to a lower bound NPV estimate for each credible option, in order to represent a conservative future state of the world with respect to potential market benefits that could be realised under the credible option;
- central scenario – the central scenario consists of assumptions that reflect Ausgrid’s central set of variable estimates which, in Ausgrid’s opinion, provides the most likely scenario; and
- high benefit scenario – this scenario reflects an optimistic set of assumptions, which have been selected to investigate an upper bound on reasonably expected market benefits.

A summary of the key variables in each scenario is provided in the table below.

Table E2 – Summary of the three scenarios investigated

Variable	Scenario 1 – central scenario	Scenario 2 – low benefits	Scenario 3 – high benefits
Demand*	POE50 Step Change	Minimum POE50 demand across AEMO scenarios	POE10 Step Change
VCR	\$61.01/kWh	\$45.76/kWh	\$76.26/kWh
Unplanned corrective maintenance cost	Central estimates	70 per cent of the central estimates	130 per cent of the central estimates
Environmental risk costs	Central estimates	70 per cent of the central estimates	130 per cent of the central estimates
Capital costs ³	Capital cost central estimates	125 per cent of capital cost estimate	75 per cent of capital cost estimate
Decommissioning costs	Central estimates	125 per cent of capital cost estimate	75 per cent of the central estimate
Discount Rate	3.44%	5.50%	2.34%

* Ausgrid has developed demand forecasts consistent with AEMO’s 2022 Integrated System Plan (ISP) forecasts for future demand growth, with AEMO’s POE50 forecasts for the ‘Step Change’ assumed in the central scenario.

Option 3 is the preferred option at this draft stage

Ausgrid proposes Option 3 as the preferred option based on the RIT-D. Expected benefits are driven primarily by reduced involuntary load shedding that would otherwise be incurred under the base case, with benefits also arising from avoided planned and reactive maintenance and avoided environmental risk costs. Option 3 is found to have the highest net market benefits under all scenarios, owing to lower capital costs and also an earlier commissioning date (compared to Option 2), allowing additional years for this option to accumulate benefits (in particular avoided unserved energy).

Figure E1– Present value of gross benefits of each credible option relative to the base case

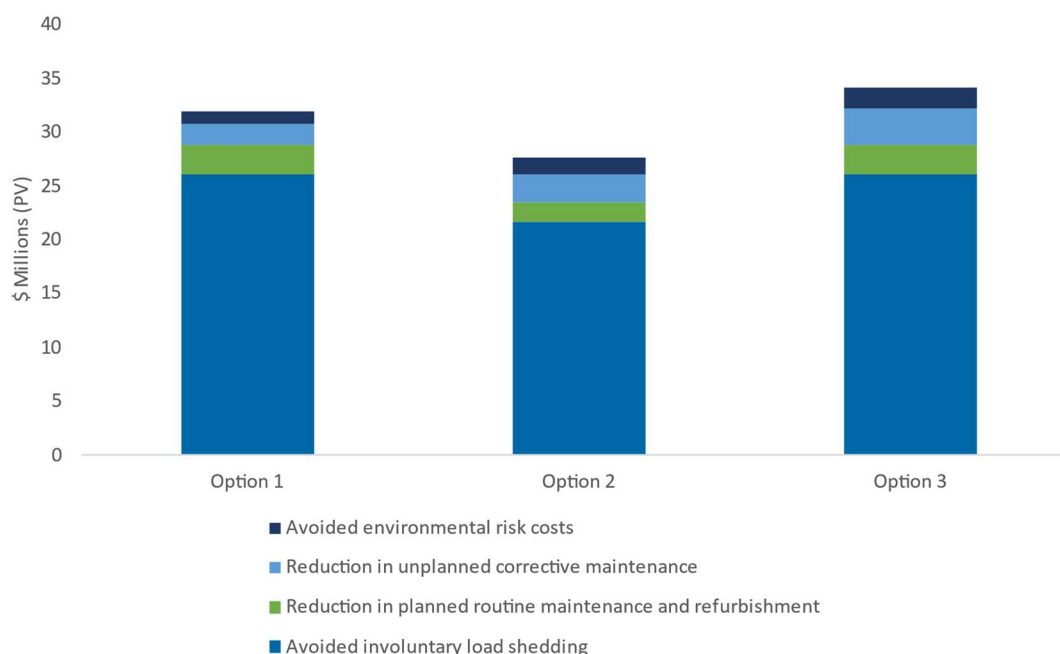

³ The variation in capital cost sensitivity also affects planned maintenance since this cost is a proportion of capital expenditure.

The table below provides a summary of the net market benefit in NPV terms for the credible option, on a weighted basis across the three scenarios. Overall, Option 3 exhibits the highest positive market benefits across all scenarios.

Table E3 – Present value results relative to the base case weighted across scenarios, \$m 2021/22

Option	PV of costs	Weighted PV of Gross Benefits	Weighted NPV	Ranking
Option 3	20.1	34.1	14.0	1

Option 3 has been found to be the preferred option, which satisfies the RIT-D. It involves the replacement of SCFF sections of feeders 9SA and 92P with new XLPE cable, with a feeder extension to loop the Zetland ZS into feeder 92P, retiring feeders 260 and 261, and deferred works to close the Zetland 132kV busbar.

Ausgrid has started engaging with key stakeholders such as the City of Sydney Council, Transgrid, Transport for NSW, the NSW Land and Housing Corporation and the local community to obtain early feedback on the preferred cable route. Ausgrid encourages community feedback and has committed to keep the community informed as the project progresses through:

- the Environmental Assessment process, including 3 week public exhibition of the assessment report and a further drop-in information session;
- in the lead up to and during construction, by door-knocks (as required), issuing notification letters and newsletters;
- launching and maintaining a dedicated project website, through the life of the project; and
- maintaining project email address and 24/7 community contact number.

The estimated capital cost of this option is \$37.1 million including decommissioning costs for feeders 260, 261, 9SA and 92P of approximately \$1.8 million. Ausgrid assumes that the necessary construction to install the new feeders will commence following completion of the regulatory process, for commissioning in 2025/26.

Once the new installation is complete, operating costs are expected to range from \$28,000 per annum in 2026 to \$35,000 per annum by 2035 (around 0.1 per cent of capital expenditure).

Ausgrid considers that this DPAR and the accompanying detailed analysis identify Option 3 as the preferred option and that this satisfies the RIT-D. Ausgrid is the proponent for Option 3.

How to make a submission and next steps

This DPAR represents the second step in the application of the RIT-D to options for ensuring reliable electricity supply to the Eastern Suburbs load area.

Ausgrid welcomes written submissions on this DPAR. Submissions are due by 2 December 2022 and should be addressed to:

Matthew Webb
 Head of Asset Investment
 Ausgrid
 GPO Box 4009
 Sydney 2001

Or

email to: assetinvestment@ausgrid.com.au

Submissions will be published on the Ausgrid website. If you do not want your submission to be publicly available please clearly stipulate this at the time of lodgement.

The next step of this RIT-D involves publication of a Final Project Assessment Report (FPAR). The FPAR will update the assessment of the net benefit associated with different investment options, in light of any submissions received on this DPAR. Ausgrid intends to publish the FPAR as soon as practicable after submissions are received on this DPAR.

1 Introduction

This Draft Project Assessment Report (**DPAR**) has been prepared by Ausgrid and represents the second step in the application of the Regulatory Investment Test for Distribution (**RIT-D**) with regard to options for ensuring reliable electricity supply to the Eastern Suburbs load area. It follows publication of the Options Screening Notice for this RIT-D.

The underground electricity subtransmission cables ('feeders') supplying the Eastern Suburbs load area include self-contained fluid filled (**SCFF**) feeders, which are now considered an obsolete and outdated technology. They are becoming less reliable and approaching the point at which their replacement maximises the net benefit for the community. Ausgrid has made a commitment to the NSW Environment Protection Authority (**EPA**) to a program of replacing or retiring all SCFF cables with known leaks by 2034, due to the environmental risks associated with oil leaking from these cables (as well as the associated decline in network reliability).

Ausgrid has identified the need to mitigate risks associated with 132kV feeders 260 and 261, which run from Beaconsfield Supply Point (**BSP**) to Zetland Zone Substation (**ZS**). If action is not taken, planning studies indicate that there will be substantial Expected Unserved Energy (**EUE**) to loads in this area of our network if these cables fail, as well as significant reactive maintenance costs associated with having to repair and restore service, and environmental risks from oil leaking from the cables.

If action is not taken, it is expected that Ausgrid's electricity distribution license reliability and performance standards will be breached.

At the same time, Ausgrid has also identified 132kV feeders 9SA and 92P as a high priority for replacement with modern technology cables, due to the environmental risks that they impose as oil leaks from the cables. Feeders 9SA and 92P run from the Beaconsfield BSP to Campbell St ZS and Belmore Park ZS respectively. They are key feeders that form part of Sydney's Inner Metropolitan Subtransmission network.

Addressing concerns associated with feeders 9SA and 92P at the same time as replacing feeders 260 and 261 offers cost efficiencies when compared to addressing them in isolation. Zetland ZS is located geographically close to feeders 9SA and 92P, and looping Zetland ZS into at least one of these feeders would allow the decommissioning of 132kV feeders 260 and 261 (without the need for replacement).

Ausgrid is therefore undertaking a RIT-D to assess options for addressing the risk that the existing ageing SCFF feeders 260, 261, 9SA and 92P pose and to ensure we continue to satisfy our reliability and performance standards.

Ausgrid has determined that non-network solutions are unlikely to form a standalone credible option, or form a significant part of a credible option, as set out in the separate Options Screening Notice released in accordance with clause 5.17.4(d) of the National Electricity Rules (NER).

1.1 Role of this draft report

Ausgrid has prepared this DPAR in accordance with the requirements of the NER under clause 5.17.4. It is the second stage of the RIT-D process set out in the NER in relation to the application of the RIT-D and follows publication of the Options Screening Notice.

The purpose of the DPAR is to:

- describe the identified need Ausgrid is seeking to address, and the assumptions used in identifying this need;
- provide a description of each credible option assessed;
- quantify relevant costs and market benefits for each credible option;
- describe the methodologies used in quantifying each class of cost and market benefit;
- explain why it is determined that some market benefits or costs do not apply to the credible options considered;
- present and explain the results of a net present value (NPV) analysis of each credible option, and
- identify the preferred option.

The next stage of this RIT-D involves the publication of a Final Project Assessment Report (FPAR). The FPAR will update the quantitative assessment of the net benefit associated with different investment options, in light of any submissions received on this DPAR. The entire RIT-D process is detailed in Appendix B.

1.2 Submissions and queries

Ausgrid welcomes written submissions on this DPAR. Submissions are due on 02 December 2022 and should be addressed to:

Matthew Webb
Head of Asset Investment
Ausgrid
GPO Box 4009
Sydney 2001

Or

email to: assetinvestment@ausgrid.com.au

Submissions will be published on the Ausgrid website. If you do not want your submission to be publicly available, please clearly stipulate this at the time of lodgement.

2 Description of the identified need

This section provides a description of the network area and the ‘identified need’ for this RIT-D, before presenting a number of key assumptions underlying the identified need.

2.1 Overview of the Eastern Suburbs subtransmission network and existing supply arrangements for the Eastern Suburbs load area

The Eastern Suburbs network area extends from South Head (at the entrance to Sydney Harbour) to La Perouse, inland to Surry Hills, and west as far as Marrickville. Within this area there is a 132kV network which supports the inner metropolitan transmission network. This network consists of 132/11kV and 33/11kV zone substations as well as gas pressured, SCFF and paper insulated feeders. The 132kV feeders 260, 261, 9SA and 92P form part of this network.

Figure 2-1 – Schematic view of the 132kV network including feeders 260, 261, 9SA and 92P

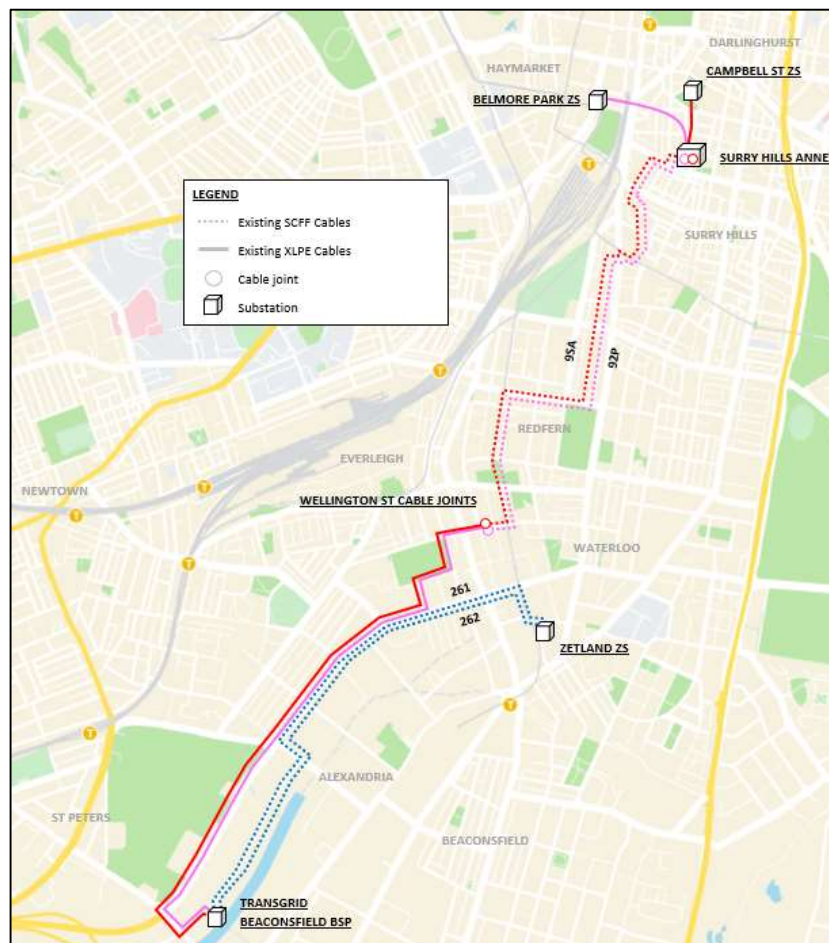

Feeders 9SA and 92P are an important part of this transmission network, connecting Transgrid’s Beaconsfield BSP with Ausgrid’s Campbell Street ZS and Belmore Park ZS. The feeders are 6.0km and 6.4km in length and were both commissioned in 1973. The sections of these feeders now residing within Ausgrid’s cable tunnels (i.e. between Surry Hills Annex, Campbell Street ZS and Belmore Park ZS) were constructed with new Cross Linked Polyethylene (XLPE) cables in 2005. The feeders were also partially replaced with XLPE cables as part of excavations linked to the WestConnex motorway project in 2017- 19, leaving 2.8km of SCFF cable remaining in each feeder.

The 132kV Feeders 260 and 261 run from Beaconsfield BSP to the Zetland ZS, are each 2.6km long and were commissioned in 1975. They provide the only connection to the Zetland ZS from Beaconsfield BSP, providing electricity service to almost 23,000 customers. As shown in the above figure, the Zetland ZS is geographically located near feeders 9SA and 92P. The proximity of Zetland ZS to the physical route of feeders 9SA and 92P provides an opportunity to address issues with these SCFF feeders at the same time as feeders 260 and 261, in a more efficient way than if they had been addressed in isolation.

2.2 Summary of the 'identified need'

Ausgrid is obliged to comply with reliability and performance standards as part of its distribution license granted by the Minister for Industry, Resources and Energy under the *Electricity Supply Act 1995 (NSW)*. Under its license, reliability and performance standards are expressed in two measures:

- SAIDI⁴ – which means the average derived from the sum of the durations of each sustained customer interruption (measured in minutes), divided by the total number of customers (averaged over the financial year); and
- SAIFI⁵ – which means the average derived from the total number of sustained customer interruptions divided by the total number of customers (averaged over the financial year).

These two reliability measures capture two key sources of inconvenience to electricity customers from supply disruptions, i.e. how long their electricity supply is off for as well as how often their electricity supply is off. Customers experience less inconvenience (i.e. a better level of supply reliability), the lower each of these measures are. Reliability standards applied to distribution networks typically set maximums in relation to each of these two measures.

The main concern relates to increasing customer supply, environmental and maintenance risks derived from the fact that these SCFF have failed in the past and experienced fluid leaks.

A concurrent outage on feeders 260 and 261, which are installed in a common trench, would result in the loss of supply to the Zetland ZS. Partial loads would be recovered via manual 11kV load transfers to nearby Zones using existing 11kV connections, but extended outages for some customers would be likely.

SCFF cables also impose environmental risks associated with oil leakages as they age. Ausgrid developed a SCFF cable management strategy which has been reviewed by the Environmental Protection Authority (EPA) and which we continue to follow. A supporting investment strategy has been implemented to replace or retire all SCFF feeders with known leaks by 2034. This strategy prioritises investments considering the expected decline in network reliability as well as environmental risks.

Feeders 260, 261, 9SA and 92P have all experienced fluid leaks over the past 15 years. Of Ausgrid's remaining SCFF cables, feeders 9SA and 92P are at the high end of environment risks, while feeders 260 and 261 are in the middle of the range. Due to their geographic proximity, addressing concerns associated with feeders 9SA and 92P at the same time as replacing feeders 260 and 261 offers cost efficiencies when compared to addressing them in isolation.

2.3 Key assumptions underpinning the identified need

The need to undertake action is predicated on the deteriorating condition of the existing 132kV underground feeders 9SA, 92P, 260 and 261 and the characteristics of any resultant outages, as well as the fact that maintaining technologies present heightened maintenance and asset failure risks.

This section summarises the key assumptions underpinning the identified need for this RIT-D. Appendix D provides additional detail on assumptions used, and methodologies applied, to estimate the costs and market benefits as part of this RIT-D.

2.3.1 Ageing SCFF 132kV Feeders are expected to increase the risk of involuntary load shedding

A key assumption underpinning the identified need is that retaining the 260 and 261 SCFF 132kV Feeders is expected to increase the risk of involuntary load shedding. The risk of involuntary load shedding from cable failure is less material for feeders 9SA and 92P, due to the presence of other feeders in the area that can help maintain supply.

The major factor contributing to the risk of involuntary load shedding is that these feeders are reaching the end of their technical life. The SCFF technology used by the feeders is also obsolete and requires specialist skills to repair and maintain. Consequently, outage times can be lengthy and spares are not readily available.

These feeders have experienced multiple oil leaks over the past 15 years. Manufacturers no longer produce these cables nor accessories for their repair. Analysis of the condition of the feeders has determined that the risk of prolonged outages is growing. Predictive failure models for these feeders (informed by ongoing condition assessments) suggest that

⁴ System Average Interruption Duration Index.

⁵ System Average Interruption Frequency Index.

expected unserved energy in the event of outages could be significant. Therefore, action to mitigate the growing supply risk should be taken as soon as practicable.

Supply or network risk is assigned for each cable based on the network configuration, available capacity under defined contingency conditions, demand forecasts and historical asset management records. A key component to this assessment is the cable failure model which forecasts the frequency of future cable failures. This model is developed from historical failure records, and then modified by cable condition indicators including Insulation Resistance tests.

The Expected Unserved Energy (EUE) forecasts for feeders 260 and 261 (Figure 2-2 below) are based on cable failure frequency and failure duration and are combined with a model of the electricity network, including the forecast pattern of demand. The cable failures are assumed to occur at a frequency determined by the cable failure model, but their impact depends on the load level at that time.

Figure 2-2 – Expected Unserved Energy forecasts for feeders 260 and 261

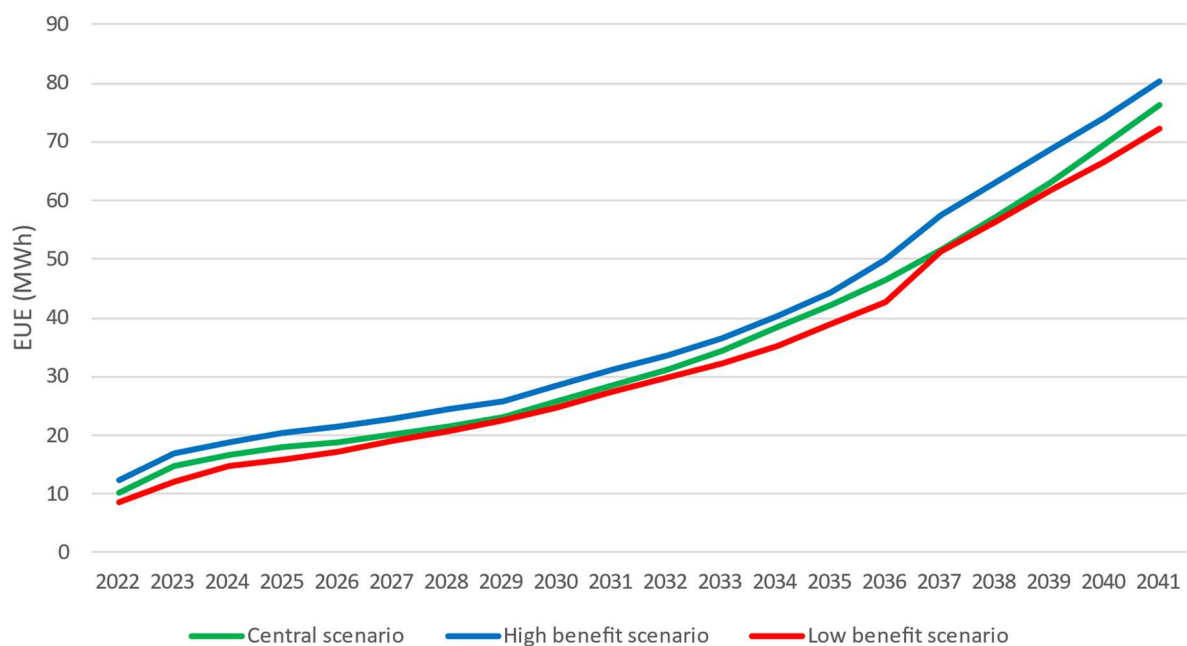

Ausgrid has developed a model to quantify the failure parameters (probabilistic distribution of outage frequency and duration) of each cable, relative to its observable condition. The failure model is applied to a probabilistic model of the network and the demand it is supplying, to estimate the long-term average amount of annual energy that is beyond the technical capability of the degraded network and therefore cannot be supplied given the expected reliability and loading levels.

2.3.2 Probability of assets failing increases with age

Network asset failure probabilities and asset unavailability have a significant effect on the expected level of involuntary load shedding. Ausgrid has adopted well-accepted models for feeders to estimate the probability of failure. For underground cables, the Crow-AMSAA model is used to determine both the probability of failure and unavailability. In general, the probability of failure increases with asset age.

Figure 2-3 below shows unavailability plotted on a logarithmic scale for a representative 10km stretch of fluid-filled cables aged zero to one hundred years.

Figure 2-3 – Unavailability of fluid-filled feeders

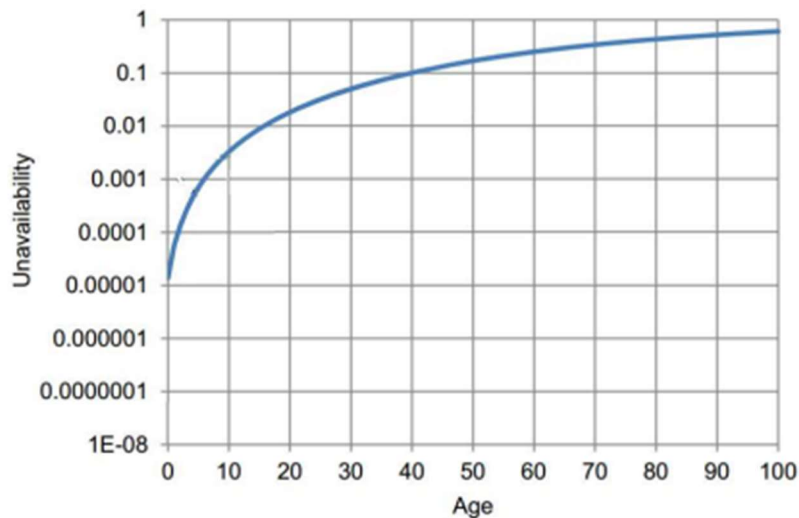

This model is also based on the relationship between the condition of a cable and its age. The Crow-AMSAA model shows that the availability of fluid-filled cables is expected to decline significantly if the cables are retained past an age of 50 years. Ausgrid considers this methodology is consistent with industry practice. A detailed discussion of the probability of failure and asset availability is provided in Appendix D.

2.3.3 Feeder redundancy exists but capacity to undertake load transfers are limited

The level of impact on customers expected from any involuntary load shedding is dependent on the level of redundancy in backup 132kV feeders and the capacity to transfer load to other zone substations in the event of 132kV cable failures.

As noted above, a concurrent outage on feeders 260 and 261, which are installed in a common trench, would result in the loss of supply to the Zetland ZS. Partial loads would be recovered via manual 11kV load transfers to nearby Zones using existing 11kV connections, but extended outages for some customers would be likely.

Cable failure modelling indicates that expected involuntary supply interruptions related to predicted failures of feeders 260 and 261 is approximately 10MWh in 2021/22 under the central scenario, increasing to 76MWh per year by 2040/41 if no corrective action is taken.

Both the degree of redundancy and the ability to transfer load elsewhere have been considered by Ausgrid in forecasting EUE. This EUE is then valued using the value of customer reliability (**VCR**) determined in accordance with the methodology developed by the Australian Energy Market Operator (**AEMO**) and using values published by the Australian Energy Regulator (**AER**). The calculation of the VCR for Zetland ZS, weighted by the load characteristics of that area, is set out in Appendix D.

As noted above, the EUE from an outage is less material for feeders 9SA and 92P due to the presence of other feeders in the area that can help maintain supply.

2.3.4 Environmental risk

In addition to the EUE, Ausgrid also models unplanned repairs and environmental risks associated with the existing SCFF feeders. A significant problem associated with SCFF feeders is the leaking of cable dielectric fluid into the surrounding environment. Environmental risk for each cable is quantified based on historical cable fluid leak volume records and knowledge of environmental sensitivity along the cable route.

Of Ausgrid's remaining SCFF cables, feeders 9SA and 92P are at the high end of environment risks, while feeders 260 and 261 are in the middle of the range. Ausgrid's analysis suggests that, considered in isolation, the optimal timing for replacement of feeders 9SA and 92P with modern equivalent cables based on the avoided reactive maintenance and environmental risk costs would be sometime in the mid-2030s. However, given their geographical proximity to feeders 260 and 261, it makes sense to consider options for this RIT-D which address all four feeders at the same time, due to the potential for cost efficiencies.

Further details of Ausgrid's approach to modelling environmental risk is contained in Appendix D.

3 Three credible options have been assessed

This section provides details of the three credible options that Ausgrid has identified as part of its network planning activities to date. All costs in this section are in 2021/22 dollars, unless otherwise stated.

3.1 Option 1 – Replace the SCFF feeders like-for-like (modern equivalent asset)

This option involves the replacement of 132kV Feeders 9SA, 92P, 260 and 261 by undertaking a like-for-like replacement using contemporary technology, which is expected to improve reliability, reduce unserved energy levels and reduce operating expenditure over time relative to the base case of maintaining the existing feeders. Under this option, the configuration of the feeders would remain unchanged from the existing network arrangement. Figure 3-1 below illustrates the single line diagram of the existing network at Zetland ZS.

Figure 3-1– Diagram of existing Zetland ZS

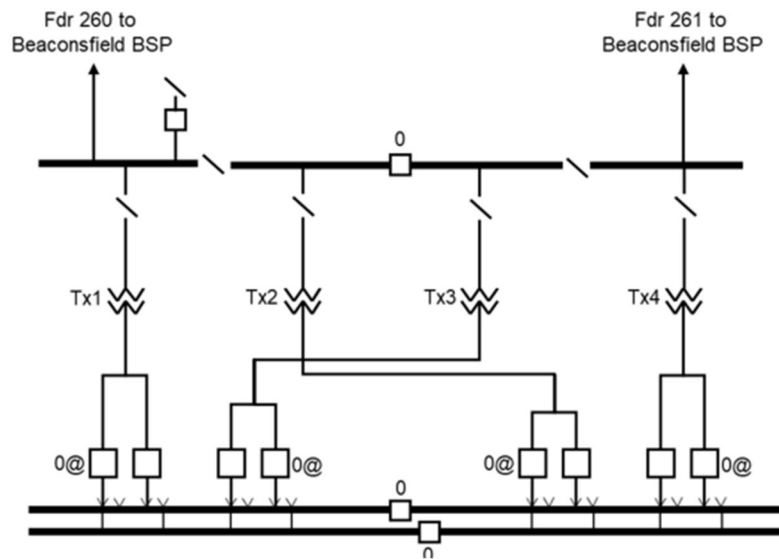

The estimated capital cost of this option (including decommissioning costs for of feeders 260, 261, 9SA and 92P) is approximately \$52.2 million.

The optimal timing analysis for this option indicates that the commissioning of feeders 260 and 261 should occur by 2025/26, with the replacement of feeders 9SA and 92P deferred to 2034/35. The staged approach to the commissioning under this option recognises considerable EUE benefits associated with the replacement of feeders 260 and 261, while the deferred replacement of feeders 9SA and 92P is consistent with Ausgrid’s commitment to the EPA in 2014 to replace or retire all SCFF with known leaks in 20 years.

Table 3-1 – Option 1 commissioning dates for components

Option	Capex (\$m, 2021/22)	Optimal timing (FY)
Replacement of 132KV SCFF feeders 260 & 261 with modern equivalent asset	\$23.7	2025/26
Replacement of 132KV SCFF feeders 9SA and 92P with modern equivalent asset	\$28.4	2034/35
Total	\$52.2	

3.2 Option 2 – Replace SCFF sections of feeders 9SA and 92P, loop Zetland ZS into feeder 92P and close Zetland 132kV busbar

This option involves the decommissioning of feeders 260 and 261, avoiding the need to replace them with updated technology. This is achieved by replacing the 132kV SCFF sections of cable in 9SA and 92P as well as a reconfiguration of feeder 92P to form feeders 92P and 9CY, each with a rating of 230MVA. Feeders 92P and 9CY would then be connected into the Zetland ZS while feeder 9SA would remain connected between the Beaconsfield BSP and the Campbell Street ZS. The proposed scope and route are set out in Figure 3-2 below.

Protection and communication upgrades would also be required at the Campbell Street ZS, Belmore Park ZS and the Beaconsfield BSP.

In addition, this option involves undertaking works to close the Zetland 132kV busbar. These works will be required in order to add another transmission path between Beaconsfield and Haymarket BSPs in the future, as described in more detail under Option 3 below.

The optimal timing analysis for this option indicates that the commissioning of the new cables and closing of the busbar under this option should occur in 2029/30.

The estimated capital cost of this option including decommissioning of feeders 260, 261, 9SA and 92P is \$40.7 million.

Figure 3-2 – Scope of work under Option 2



Figure 3-3 below illustrates the existing and proposed network arrangement at Zetland ZS under this Option 2.

Figure 3-3 Existing and proposed diagram of Zetland ZS under Option 2

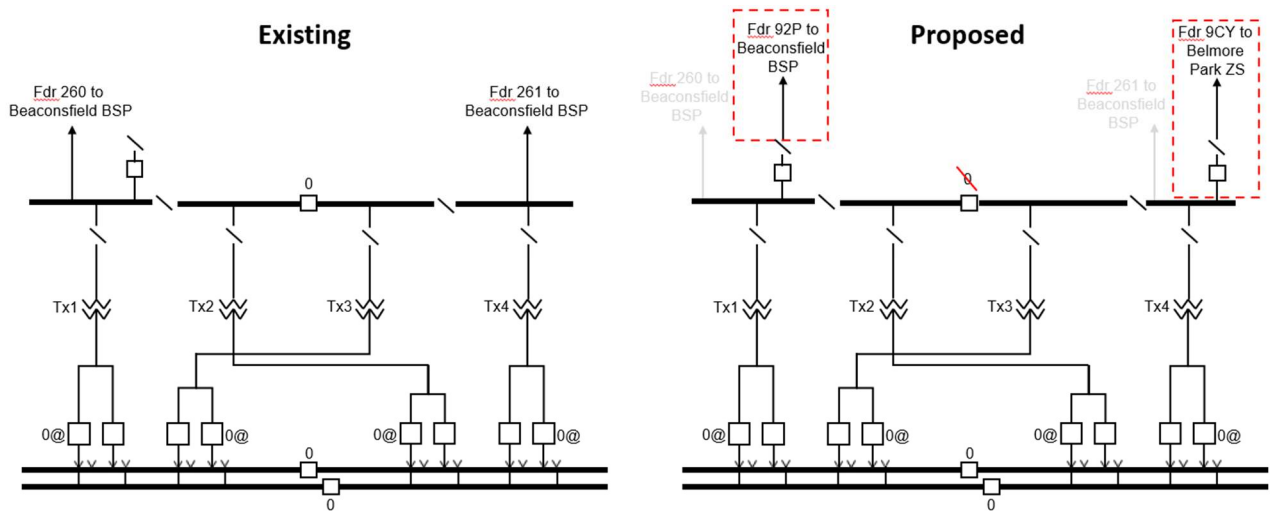

3.3 Option 3 – Replace SCFF sections of feeders 9SA and 92P, loop Zetland ZS into feeder 92P and defer works on closing Zetland 132kV busbar

This option is similar to the specification of Option 2 but involves staged replacement works to replace the feeders initially, by looping Zetland ZS into feeder 92P, and the works to close the Zetland ZS 132kV busbar at a later date.

In the future another transmission path will be required between Beaconsfield and Haymarket BSPs, once SCFF feeders 90T/1 and 9S2 are retired, requiring the 132kV bus section circuit breaker at Zetland ZS to be operated normally closed. Zetland ZS will be a dual function asset, becoming a transmission node on the completion of the project.

Figure 3-4 shows the works to be undertaken in Option 3, with the initial stage of proposed feeder replacement works and the ultimate network arrangement to be completed in a second and final stage.

Figure 3-4 Diagram of proposed works at Zetland ZS under Option 3

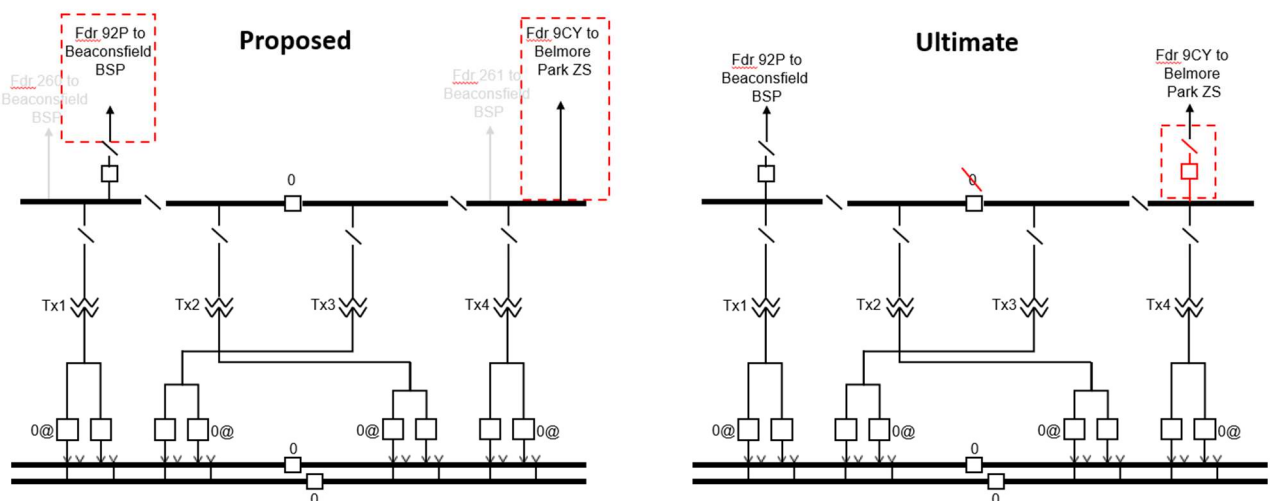

This estimated capital cost of this option (including decommissioning of feeders 260, 261, 9SA and 92P) is \$37.1 million. Option 3's capital and decommissioning costs are \$3.6m lower compared to Option 2. This is because the timing of the works in Option 3 means that they would occur as part of a broader replacement program with several other fluid filled cables in Ausgrid's network, attracting a volume discount from the successful contractor. A similar volume discount would not be achieved under Option 2, given the later commissioning date of 2029/30 under this option.

Option 3 would be commissioned in two stages, with feeders 260 and 262 replaced by 2025/26, while augmentation expenditure to close the Zetland 132kV busbar is deferred until 2034/35.

3.4 Options considered but not progressed

Ausgrid also considered several other options that have not been progressed into the RIT-D. In general, these options were not progressed because they were found to be technically infeasible or economically infeasible.

The table below summarises Ausgrid's consideration and position on each of these potential options.

Table 3-2 – Options considered but not progressed

Option	Description	Reason why option was not progressed
Non-network options	Using non-network solutions either in combination with, or in-place of, a network option.	<p>An assessment of demand management options has shown that non-network alternatives would not be cost effective nor contribute in any material way to address the identified network need.</p> <p>This result is driven primarily by the significant amount of EUE that the identified network option allows to be avoided, compared to base case, and the cost of demand management solutions. This is detailed further in the separate Options Screening Notice released in accordance with clause 5.17.4(d) of the NER.</p>
New 132/11kV zone substation and retirement of Zetland ZS	Establishment of a new 132/11kV ZS at a new site and retirement of Zetland ZS.	<p>Historically, due to high and increasing Zetland ZS load forecasts, establishing a new zone substation was a solution being considered to address identified asset condition issues and increase capacity at this site. Multiple future scenarios were considered (i.e. scenario planning), including those with substantially increased load.</p> <p>This assessment has led to the new zone substation option not being pursued further, because investments to increase capacity will have no value added if the load remains below N capacity (i.e. all equipment at Zetland ZS in service). The latest load forecast scenarios do not even reach N-1 capacity (i.e. one element out of service at Zetland ZS) in a 20-year planning.</p>
Loop Zetland ZS into feeder 9SA or 92P without replacement of SCFF portions	Decommissioning of 260/261 and loop Zetland ZS into feeder 9SA or 92P without replacement of SCFF portions.	<p>This option is not considered prudent because it would require joining the new cable extensions into the old cable feeders, requiring significant 'joining' assets (at a cost of \$2 million) which would become rapidly obsolete once the SCFF sections of 9SA and 92P were replaced. It would also not fully address the load at risk, as the load from feeders 260 and 261 would remain at risk of disruption following an outage of 9SA or 92P, and so there would still be EUE under this option.</p>

4 How the options have been assessed

This section outlines the methodology that Ausgrid has applied in assessing market benefits and costs associated with the credible options considered in this RIT-D. Appendix D presents additional detail on the assumptions and methodologies employed to assess the options.

4.1 General overview of the assessment framework

All costs and benefits for each credible option have been measured against a 'business as usual' base case. Under this base case, Ausgrid will escalate regular and reactive maintenance activities as the probability of failure and outages increases over time in the absence of an asset replacement program, as well as consequent escalation of unserved energy and environmental risk costs.

The RIT-D analysis has been undertaken over a 20-year period, from 2021-22 to 2040-41. Ausgrid considers that a 20-year period takes into account the size, complexity and expected life of the relevant credible options to provide a reasonable indication of the market benefits and costs of the options.

Where the capital components of the credible options have asset lives greater than 20 years, Ausgrid has taken a terminal value approach to incorporate capital costs in the assessment, which ensures that the capital cost of long-lived options is appropriately captured in the 20-year assessment period. This ensures that all options have their costs and benefits assessed over a consistent period, irrespective of option type, technology or asset life. The terminal values have been calculated as the undepreciated value of capital costs at the end of the analysis period and can be interpreted as a conservative estimate for benefits (net of operating costs) arising after the analysis period.

Ausgrid has adopted a real, pre-tax discount rate of 3.44% as the central assumption for the NPV analysis. This represents Ausgrid's opportunity costs for its capital investments, based on the guidelines provided in the AER rate of return instrument. As no non-network options have been found to be viable, Ausgrid considers that the appropriate discount rate is the regulated cost of capital.

To test the sensitivity of the results against changes in the discount rate, a value of 2.34% has been adopted for the lower bound discount rate, to reflect the average of the latest AER Final Decision for a DSNP's regulated weighted average cost of capital (WACC) at the time of preparing this DPAR⁶. This is approximately 32% lower than the central discount rate assumption. For the upper bound discount rate, the value of 5.50% is adopted to consider the scenario prepared by AEMO for the 2022 Integrated System Plan (ISP). Whilst the use of a symmetrical upward adjustment of the discount rate (in this case 4.48%) may also be a reasonable representation, the adoption of 5.50% is deemed a more appropriate contemporary representation of a boundary value.

4.2 Ausgrid's approach to estimating project costs

Ausgrid has estimated capital costs by considering the scope of works necessary under each credible option together with costing experience from previous projects of a similar nature. Where possible, Ausgrid has also estimated capital costs using supplier quotes or other pricing information.

Operating and maintenance costs have been determined for each option by comparing the operating and maintenance costs with the option in place to the operating and maintenance costs without the option in place. These costs are included for each year in the planning period. If operating and maintenance costs are reduced with an option in place, the cost savings are effectively treated as a benefit in the assessment.

Operating costs have been estimated for the credible options and the base case by taking into account:

- the probability and expected level of network asset faults, which translates to the level of corrective maintenance costs; and
- the level of regular maintenance required to maintain network assets in good working order, including planned refurbishment costs.

All options reduce the incidence of asset failures relative to the base case, and hence the expected operating and maintenance costs associated with restoring supply.

⁶ Specifically, we take a straight average of the real, pre-tax WACCs for the Victorian DNSPs (since they represent the latest Final Decision(s) by the AER).

Ausgrid has also included the financial costs associated with corrective maintenance and environmental outcomes that are assumed to be avoided under each of the options, relative to the base case. These costs have been estimated using internal Ausgrid estimates. Details of the assumptions and methodologies adopted to estimate these avoided costs are presented in Appendix D.

4.3 Market benefits are expected from reduced involuntary load shedding

Ausgrid considers that the only relevant category of market benefits prescribed under the NER for this RIT-D relate to changes in involuntary load shedding. The approach Ausgrid has adopted to estimating reductions in involuntary load shedding is outlined in section 4.3.1 below. Further details on the assumptions and methodology considered are presented in Appendix D. In addition, Appendix C summarises the market benefit categories that Ausgrid considers are not material for this RIT-D.

4.3.1 Reduced involuntary load shedding

Involuntary load shedding occurs when a customer's load is interrupted from the network without their agreement or prior warning. This relates to the availability of network connectivity and design configuration at the substation. It also arises from the unavailability of network elements and the resulting reduction in network capacity to supply the load.

The EUE is the probability weighted average amount of load that customers request to utilise but would need to be involuntarily curtailed due to loss of network connectivity or a network capacity limitation. Ausgrid has forecast load over the assessment period and has quantified the EUE by comparing forecast load to network capabilities under system normal and network outage conditions. A reduction in involuntary load shedding expected from an option, relative to the base case, results in a positive contribution to market benefits of the credible option being assessed.⁷

The market benefit that results from reducing the involuntary load shedding with a network solution is estimated by multiplying the quantity of expected unserved energy in MWh by the VCR. The VCR is measured in dollars per MWh and is used as proxy to evaluate the economic impact of unserved energy on customers under the RIT-D. Ausgrid has applied a central VCR estimate of \$61.01/kWh (June 2022), reflecting a load weighted value for the affected load at Zetland ZS calculated using the NSW and ACT VCR estimates (for residential, commercial and industrial load) derived by the AER in its VCR Final Report⁸, adjusted by the Consumer Price Index (CPI) to be in 2021/22 dollars. A breakdown of how the central load weighted VCR has been calculated is provided in Appendix D.

We have also reflected VCR estimates in the scenarios that are 30 per cent lower and 30 per cent higher than the central rate, consistent with the AER's specified +/- 30 per cent confidence interval.⁹

In addition, Ausgrid has investigated how assuming different load forecasts going forward changes expected market benefits under each option. Ausgrid has developed an updated set of load forecasts that draw on the latest ISP released by AEMO on 30 June 2022. Three future load forecasts for the area in question have been investigated:

- the central forecast uses 50 percent probability of exceedance ('POE50') under AEMO's Step Change scenario;
- the low demand forecast reflects the minimum demand forecast across AEMO's Slow Change, Progressive Change, Step Change and Strong Electrification scenarios for each year; and
- the high forecast reflects POE10 demand from AEMO's Step Change scenario.

These updated forecasts consider an increased uptake of energy efficiency and electrification to account for an accelerated decarbonisation to meet net zero by 2050, as well as an electric vehicle forecast that is much higher in the earlier years compared to previous forecasts and a rapid conversion of residential gas to electricity. The load forecasts provide a reasonable representation of what can be expected in the Zetland and Waterloo load areas.

Figure 4-1 below shows the assumed levels of EUE under each of the three underlying demand forecasts investigated over the next twenty years. For clarity, this figure illustrates the MWh of EUE prior to feeder replacement, taking into consideration the underlying demand forecasts and the assumed failure rates associated with keeping the existing network assets in service.

⁷ Although the levels of EUE rise to relatively substantial levels, they are not at levels which distort the comparison between the options being considered. Ausgrid has not therefore 'capped' the USE levels for the purpose of this RIT-D assessment.

⁸ AER, *Values of Customer Reliability Review – Final Report on VCR values* – December 2019. <https://www.aer.gov.au/system/files/AER%20-%20Values%20of%20Customer%20Reliability%20Review%20-%20Final%20Report%20-%20December%202019.pdf>

⁹ AER, *Values of Customer Reliability – Final Report on VCR values*, December 2019, p. 84.

Figure 4-1 – Assumed expected unserved energy (EUE) under each of the three demand forecasts

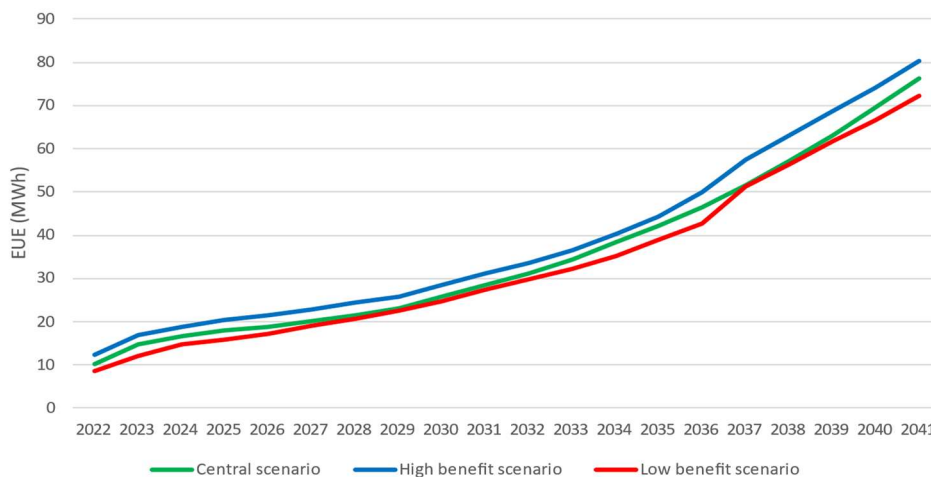

4.4 Three different ‘scenarios’ have been modelled to address uncertainty

RIT-D assessments are required to be based on cost-benefit analysis that includes an assessment of ‘reasonable scenarios’, which are designed to test alternate sets of key assumptions and whether they affect identification of the preferred option. Ausgrid has elected to assess three alternative future scenarios – namely:

- low benefit scenario – Ausgrid has adopted a number of assumptions that give rise to a lower bound NPV estimate for each credible option, in order to represent a conservative future state of the world with respect to potential market benefits that could be realised under the credible options;
- central scenario – the central scenario consists of assumptions that reflect Ausgrid’s central set of variable estimates which, in Ausgrid’s opinion, provides the most likely scenario; and
- high benefit scenario – this scenario reflects an optimistic set of assumptions, which have been selected to investigate an upper bound on reasonably expected market benefits.

A summary of the key variables in each scenario is provided in the table below.

Table 4-1 – Summary of the three scenarios investigated

Variable	Scenario 1 – central	Scenario 2 – low benefits	Scenario 3 – high benefits
Demand*	POE50 Step Change	Minimum POE50 demand across AEMO scenarios	POE10 Step Change
VCR	\$61.01/kWh	\$45.76/kWh	\$76.26/kWh
Unplanned corrective maintenance cost	Central estimates	70 per cent of the central estimates	130 per cent of the central estimates
Environmental risk costs	Central estimates	70 per cent of the central estimates	130 per cent of the central estimates
Capital costs	Capital cost central estimates	125 per cent of capital cost estimate	75 per cent of capital cost estimate
Decommissioning costs	Central estimates	125 per cent of capital cost estimate	75 per cent of the central estimate
Discount Rate	3.44%	5.50%	2.34%

* The demand forecasts align with those used by AEMO in the 2022 ISP.

Ausgrid considers that the central scenario is the most likely, since it is based on a set of expected/central assumptions. Ausgrid has therefore assigned this scenario a weighting of 50 per cent, with the other two scenarios being weighted equally with 25 per cent each.

5 Assessment of the credible options

This section provides the assessment of the credible network options Ausgrid has identified as part of its network planning activities to date. These options are compared against the base case 'do nothing' option.

5.1 Gross market benefits estimated for the credible options

The table below summarises the gross market benefit of the credible options relative to the base case in present value terms. The gross market benefit for each option has been calculated for each of the three reasonable scenarios outlined in the section above.

Option 3 is found to have the highest gross market benefits compared to Options 1 and 2 across all scenarios and also on a weighted basis. Option 3 is commissioned earlier than Option 2 (allowing more time to accrue benefits, particularly in relation to unserved energy), and is also expected to result in larger avoided unplanned corrective maintenance costs and larger avoided environmental risk costs than the other proposed options.

Table 5-1 – Present value of gross benefits of credible options relative to the base case, \$m 2021/22

Option	Central scenario	Low benefit scenario	High benefit scenario	Weighted benefits
Scenario weighting	50%	25%	25%	
Option 1	31.2	17.4	48.1	32.0
Option 2	27.0	14.7	42.0	27.7
Option 3	33.3	18.7	51.1	34.1

Figure 5.1 below provides a breakdown of all benefits relating to the credible options. For clarity, we have combined in this chart the category of 'market benefit' estimated (i.e. reduced involuntary load shedding or EUE) with the avoided costs under each option.¹⁰ The primary benefit is estimated to be avoided EUE for all options on account of the increasing likelihood of failure of feeders 260 and 261, which are nearing the end of their technical and serviceable lives.

Figure 5-1 – Gross benefits of credible options relative to the base case under the central scenario, \$m 2021/22

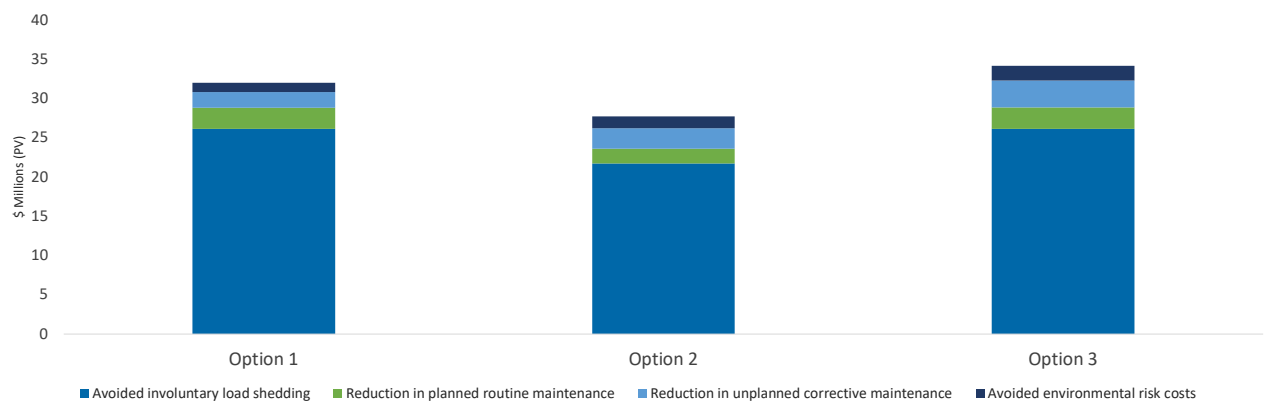

5.2 Estimated costs for the credible options

Table 5.2 below summarises the costs of the credible options relative to the base case in present value terms. The cost is the sum of the project capital costs associated with each option. The central scenario reflects the most likely expected

¹⁰ i.e. avoided corrective maintenance cost benefits (i.e. reduced unplanned corrective maintenance when assets fail); avoided planned routine maintenance; and reduced operating costs associated with lower environmental risk costs.

costs of each option, while the low and high benefit scenarios reflect (among other things) +/- 25 per cent adjustment to capital costs and higher/lower discount rates to account for uncertainty.¹¹

The cost of each option has been calculated for each of the three reasonable scenarios, in accordance with the approaches set out in Section 4.

Table 5-2 – Present value of costs of the credible options relative to the base case, NPV \$m 2021/22

Option	Central scenario	Low benefit scenario	High benefit scenario	Weighted costs
Scenario weighting	50%	25%	25%	
Option 1	20.8	28.0	14.3	21.0
Option 2	17.8	23.9	12.3	17.9
Option 3	19.8	27.5	13.5	20.1

5.3 Net present value assessment outcomes

Table 5-3 below summarises the net market benefit in NPV terms for the credible option under each scenario. The net market benefit is the gross market benefit (as set out in Table 5-1) minus the cost of the option (as set out in Table 5-2), all in present value terms.

Overall, Option 3 exhibits the highest estimated net market benefits across all scenarios, owing to its lower capital cost and also an earlier commissioning date (compared to Option 2), which allows for a greater amount of unserved energy benefits, environmental risk benefits and unplanned maintenance to accrue.

Table 5-3 – Present value of weighted net benefits relative to the base case, \$m 2021/22

Option	Central scenario	Low benefits scenario	High benefits scenario	Weighted	Ranking
Option 1	10.4	-10.6	33.7	11.0	2
Option 2	9.3	-9.2	29.7	9.7	3
Option 3	13.6	-8.8	37.6	14.0	1

5.4 Sensitivity analysis results

Ausgrid has undertaken a thorough sensitivity testing exercise to understand the robustness of the RIT-D assessment to underlying assumptions about key variables.

In particular, we have undertaken two tranches of sensitivity testing – namely:

- step 1 – testing the sensitivity of the optimal timing of the project (“trigger year”) to different assumptions in relation to key variables; and
- step 2 – once a trigger year has been determined, testing the sensitivity of the total NPV benefit associated with the investment proceeding in that year, in the event that actual circumstances turn out to be different.

That is, Ausgrid has undertaken sensitivity analysis to first determine the optimal timing of the project, to then to conclude that a particular year represents the ‘most likely’ date at which the project will be needed.

Having assumed to have committed to the project by this date, Ausgrid has also looked at the consequences of ‘getting it wrong’ under step 2 of the sensitivity testing. That is, if demand turns out to be lower than expected, for example, what would be the impact on the net market benefit associated with the project continuing to go ahead on that date.

We outline how each of these two steps has been applied to test the sensitivity of the key findings.

¹¹ Operating costs associated with a reduction in planned maintenance costs is captured as a benefit and reflected in the figures presented in Table 5-1.

5.4.1 Step 1 – Sensitivity testing of the assumed optimal timing for the credible option

Ausgrid has estimated the optimal timing for each option according to when the expected annual benefit from the proposed option exceeds its annualised cost, consistent with the AER guidance on how to determine the economically prudent and efficient timing for asset retirement.¹² This process was undertaken for both the central set of assumptions (i.e. the central scenario) as well as a range of alternative assumptions for key variables.

This section outlines the sensitivity of the identification of the commissioning year to changes in the underlying assumptions. In particular, the optimal timing of the options is found to be invariant to the assumptions of:

- a 25 per cent increase/decrease in the assumed network capital costs;
- alternative forecasts of maximum demand growth, based on POE10 Step Change (high) and aggregated minimum demand values from ISP scenarios (low);
- a lower VCR (\$45.8/kWh) and a higher VCR (\$76.3/kWh);
- lower and higher assumed avoided reactive maintenance costs (+/- 30 per cent);
- lower and higher assumed environmental risk costs (+/- 30 per cent); and
- a higher/lower discount rate.

The figures below outline the impact on the optimal commissioning year for each option, under a range of alternative assumptions. Figure 5-2 illustrates that for Option 1, the optimal commissioning date is found to be in 2025/26. Figure 5-3 illustrates that for Option 2, the optimal commissioning date is found to be in 2029/30. Figure 5-4 shows that for Option 3 commissioning in 2025/26 is optimal under all sensitivities modelled.

Figure 5-2 – Option 1’s distribution of optimal project commissioning years under each sensitivity (feeders 260 and 261)

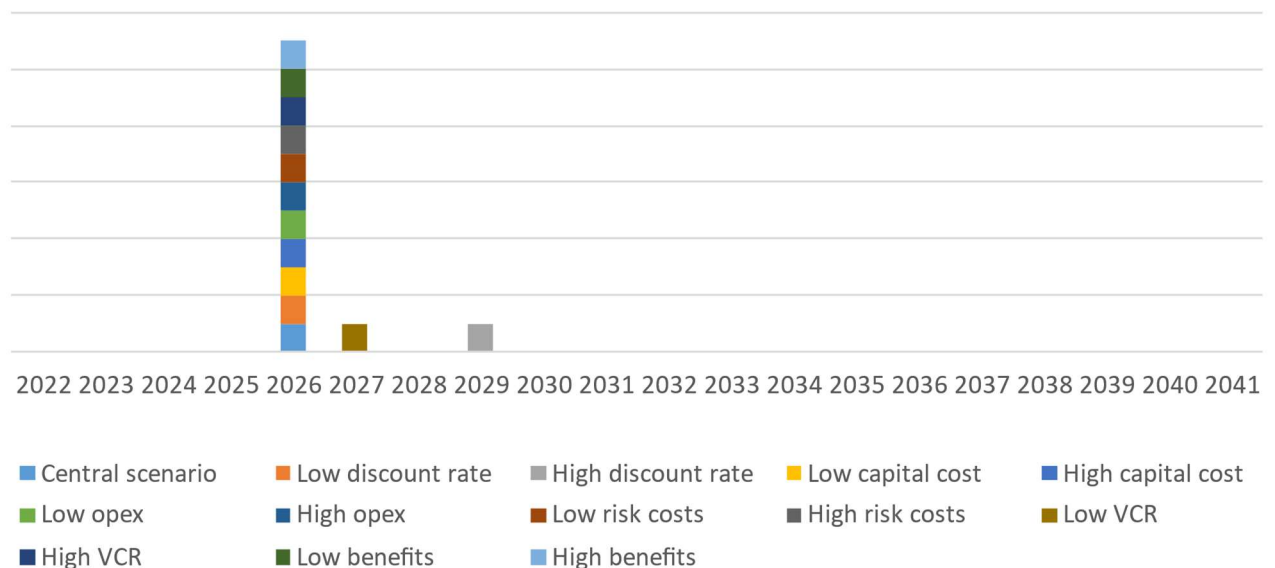

¹² AER, *Industry practice application note – Asset replacement planning*, January 2019, p. 37.

Figure 5-3 – Option 2’s distribution of optimal project commissioning years under each sensitivity

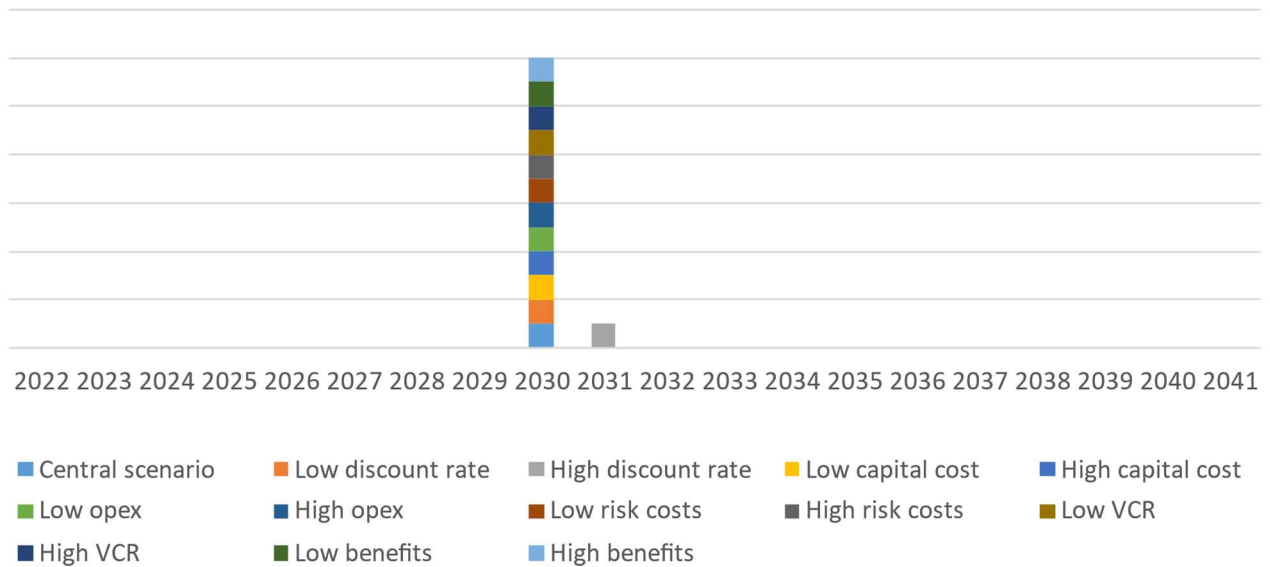

Figure 5-4 - Option 3’s distribution of optimal project commissioning years under each sensitivity



5.4.2 Step 2 – Sensitivity of the overall net market benefit

Ausgrid has also conducted sensitivity analysis on overall net market benefits, based on the assumed option timing established in step 1.

Specifically, Ausgrid has investigated the same sensitivities under this second step as in the first step, i.e.:

- a 25 per cent increase/decrease in the assumed network capital costs;
- at 30 per cent increase/decrease in the environmental risk costs;
- alternative forecasts of maximum demand growth, based on POE10 Step Change (high) and aggregated minimum demand values from ISP scenarios (low);
- a lower VCR (\$45.8/kWh) and a higher VCR (\$76.3/kWh);
- lower and higher assumed avoided unplanned corrective maintenance costs (+/- 30 per cent); and
- a higher/lower discount rate.

The results of the sensitivity test are presented in Table 5.4 below. Option 3 has the highest net market benefits over and above the base case across all sensitivities modelled. This generally follows from Option 3's lower capital cost and also early commissioning (compared to Option 2), which results in lower unserved energy, reduction in environmental risk and reduction in unplanned maintenance costs earlier in the analysis period.

The sensitivity results also demonstrate that Option 1 outperforms Option 2 on a net market benefits basis across all sensitivities.

Table 5-4 – Sensitivity testing results under the central scenario, \$m PV 2021/22

Sensitivity	Option 1	Option 2	Option 3
Central scenario	10.4	9.3	13.6
25 per cent higher capital cost	5.2	4.8	8.6
25 per cent lower capital cost	15.6	13.7	18.5
Unserved energy under POE10 conditions	12.6	10.9	15.8
Unserved energy under POE 90 conditions	9.2	8.3	12.4
VCR \$76.3/kWh	16.8	14.5	19.9
VCR \$45.8/kWh	4.1	4.0	7.2
Lower discount rate	16.7	15.1	20.2
Higher discount rate	1.9	1.4	4.2
Higher unplanned corrective maintenance	11.0	10.0	14.6
Lower unplanned corrective maintenance	9.8	8.5	12.5
Higher environmental risk costs	10.8	9.7	14.1
Lower environmental risk costs	10.1	8.8	13.0

6 Proposed preferred option and community consultation

Ausgrid proposes Option 3 as the preferred option that satisfies the RIT-D. This option involves the decommissioning of feeders 260 and 261. This is achieved by replacing 132kV SCFF sections of cable in 9SA and 92P as well as reconfiguration of feeder 92P to form feeders 92P and 9CY, each with a rating of 230MVA. Feeders 92P and 9CY will be connected into the Zetland ZS and 9SA will remain connected between the Beaconsfield BSP and the Campbell Street ZS. Once installed, the existing SCFF feeders will be decommissioned. Under this option, the necessary closing of the 132kV busbar at Zetland is deferred until 2034/35.

Option 3 has been determined to be the preferred option on the basis that it results in the highest Net Present Value in the modelling assessment across all scenarios.

The estimated capital cost of this option is \$37.1 million including decommissioning costs for feeders 260, 261, 9SA and 92P of approximately \$1.8 million. Ausgrid assumes that the necessary construction to install the new feeders will commence in 2022/23 following completion of the regulatory process, for commissioning in 2025/26.

Once the new installation is complete, operating costs are expected to scale up from approximately \$28,000 in 2026 to \$35,000 per annum by 2035 (around 0.1 per cent of capital expenditure).

Ausgrid considers that this DPAR, and the accompanying detailed analysis, identifies Option 3 as the preferred option and that this satisfies the RIT-D. Ausgrid is the proponent for Option 3.

6.1 Community consultation

This DPAR forms the second step in the RIT-D process, and Ausgrid welcomes submissions (see section 1.2).

Ausgrid has started engaging with key stakeholders such as the City of Sydney Council, Transgrid, Transport for NSW, the NSW Land and Housing Corporation and the local community to obtain early feedback on the preferred cable route.

Ausgrid encourages community feedback and has committed to keep the community informed as the project progresses through:

- the Environmental Assessment process, including a 3 week public exhibition of the assessment report and further drop-in information session;
- in the lead up to and during construction, by door-knocks (as required), issuing notification letters and newsletters;
- launching and maintaining a dedicated project website, through the life of the project; and
- maintaining project email address and 24/7 community contact number.

Appendix A – Checklist of compliance clauses

This section sets out a compliance checklist that demonstrates the compliance of this DPAR with the requirements of clause 5.17.4(r) of the National Electricity Rules version 188.

Clause	Summary of requirements	Section in the DPAR
5.17.4(r)	The matters specified as requirements for the draft project assessment report, as outlined below in clause 5.17.4(j).	See below
5.17.4(r)	A summary of any submissions received on the draft project assessment report and the RIT-D proponent's response to each such submission	NA
5.17.4(j)	(1) a description of the identified need for the investment	0
	(2) the assumptions used in identifying the identified need	2.3
	(3) if applicable, a summary of, and commentary on, the submissions on the non-network options report	NA
	(4) a description of each credible option assessed	3
	(5) where a DNSP has quantified market benefits, a quantification of each applicable market benefit for each credible option	5.1
	(6) a quantification of each applicable cost for each credible option, including a breakdown of operating and capital expenditure	5.2
	(7) a detailed description of the methodologies used in quantifying each class of cost and market benefit	4
	(8) where relevant, the reasons why the RIT-D proponent has determined that a class or classes of market benefits or costs do not apply to a credible option	Appendix C
	(9) The results of a net present value analysis of each of credible option and accompanying explanatory statements regarding the results	5
	(10) the identification of the proposed preferred option	6
	(11) for the proposed preferred option, the RIT-D proponent must provide: (i) details of technical characteristics; (ii) the estimated construction timetable and commissioning date (where relevant); (iii) the indicative capital and operating cost (where relevant); (iv) a statement and accompanying detailed analysis that the proposed preferred option satisfies the regulatory investment test for distribution; and (v) if the proposed preferred option is for reliability corrective action and that option has a proponent, the name of the proponent	6
	(12) Contact details for a suitably qualified staff member of the RIT-D proponent to whom queries on the draft report may be directed.	1.2

Appendix B – Process for implementing the RIT-D

For the purposes of applying the RIT-D, the NER establishes a three-stage process: (1) the Non-Network Options Report (or notice circumventing this step); (2) the DPAR; and (3) the FPAR. This process is summarised in the figure below.

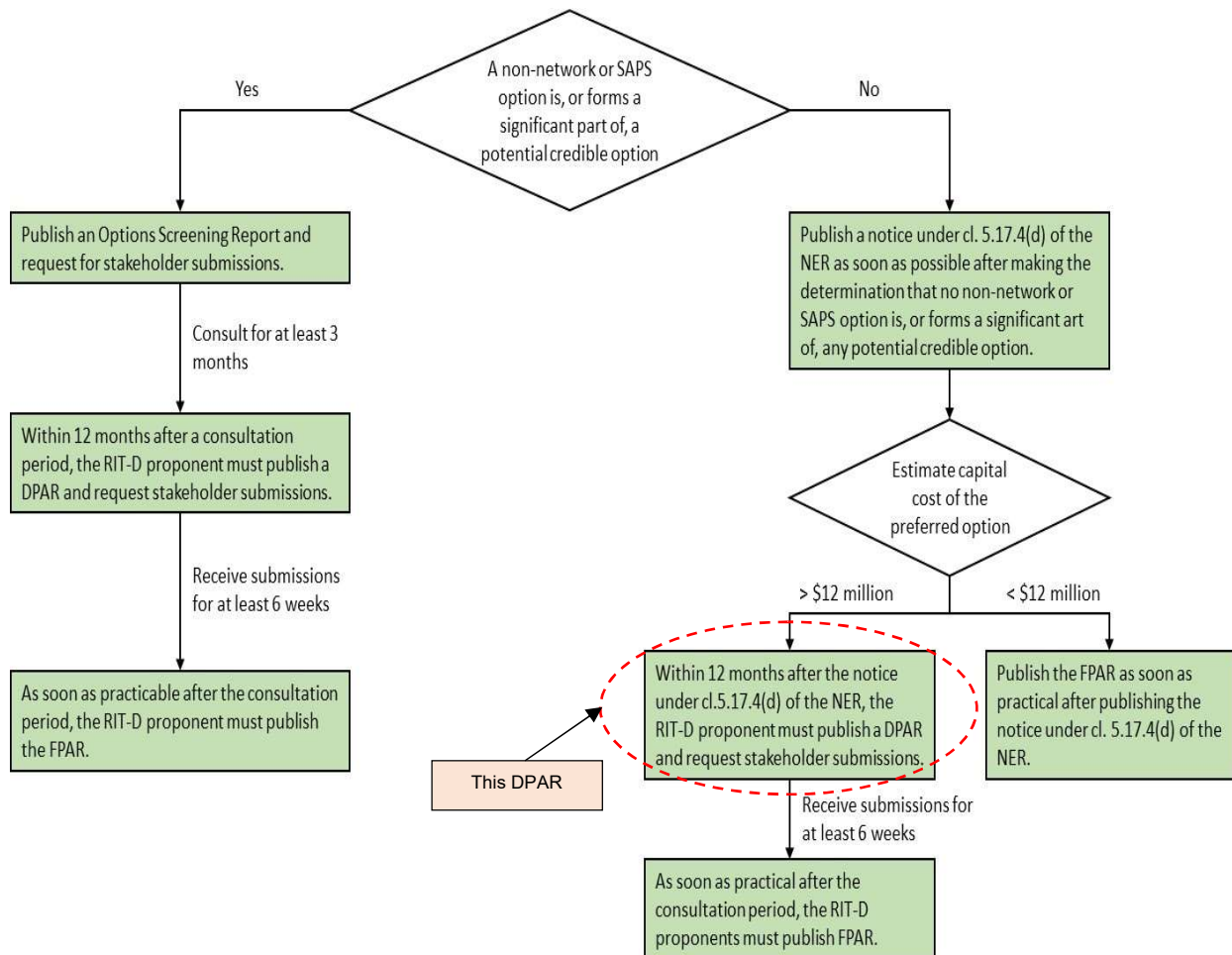

Appendix C – Market benefit classes considered not relevant

The market benefits that Ausgrid considers will not materially affect the outcome of this RIT-D assessment include:

- changes in the timing of unrelated expenditure;
- changes in voluntary load curtailment;
- changes in costs to other parties;
- changes in load transfer capability and capacity of embedded generators to take up load;
- Option value; and
- changes in electrical energy losses.

The reasons why Ausgrid considers that each of these categories of market benefit is not expected to be material for this RIT-D are outlined in the table below.

Table C.1 – Market benefit categories under the RIT-D not expected to be material

Market benefits	Reason for excluding from this RIT-D
Timing of unrelated expenditure	Ausgrid does not expect the project will have any effect on unrelated expenditures in other parts of the network. Accordingly, Ausgrid considers the market benefit from changes in timing of unrelated expenditure is not material.
Changes in voluntary load curtailment	<p>Ausgrid notes that the level of voluntary load curtailment currently present in the National Electricity Market (NEM) is limited. Where the implementation of a credible option affects pool price outcomes, and in particular results in pool prices reaching higher levels on some occasions than in the base case, this may have an impact on the extent of voluntary load curtailment.</p> <p>Ausgrid notes that none of the options are expected to affect the pool price and so there is not expected to be any changes in voluntary load curtailment.</p>
Costs to other parties	This category of market benefit typically relates to impacts on generation investment from the options. Ausgrid notes that none of the options will affect the wholesale market and so we have not estimated this category of market benefit.
Changes in load transfer capacity and embedded generators	Load transfer capacity between substations is predominantly limited by the high voltage feeders that connect substations. Credible options under consideration do not affect high voltage feeders and therefore are unlikely to materially change load transfer capacity. Further, credible options are unlikely to enable embedded generators in Ausgrid's network to be able to take up load given the size and profile of the load serviced by network assets currently considered for replacement. Consequently, Ausgrid has not attempted to estimate any benefits from changes in load transfer capacity and embedded generators.
Option value	Option values arise where there is uncertainty regarding future outcomes, the information that is available in the future is likely to change, and the credible options considered have sufficiently flexible to respond to that change. Ausgrid notes that the credible option assessed does not involve stages or any other flexibility and so we do not consider that option value is relevant.
Changes in electrical energy losses	Ausgrid does not expect that any of the credible options considered would lead to significant changes in network losses and so have not estimated this category of market benefits.

Appendix D – Additional detail on the assessment methodology and assumptions

This appendix presents additional detail on the supply restoration assumptions and probability of failure assumptions.

D.1 Characteric load duration curve

The load duration curve used in the analysis is presented in Figure D.1-1 below.

It is assumed that the load types supplied will not change substantially into the future and therefore the load duration curve will maintain its characteristic shape.

Figure D.1 – Load duration curve

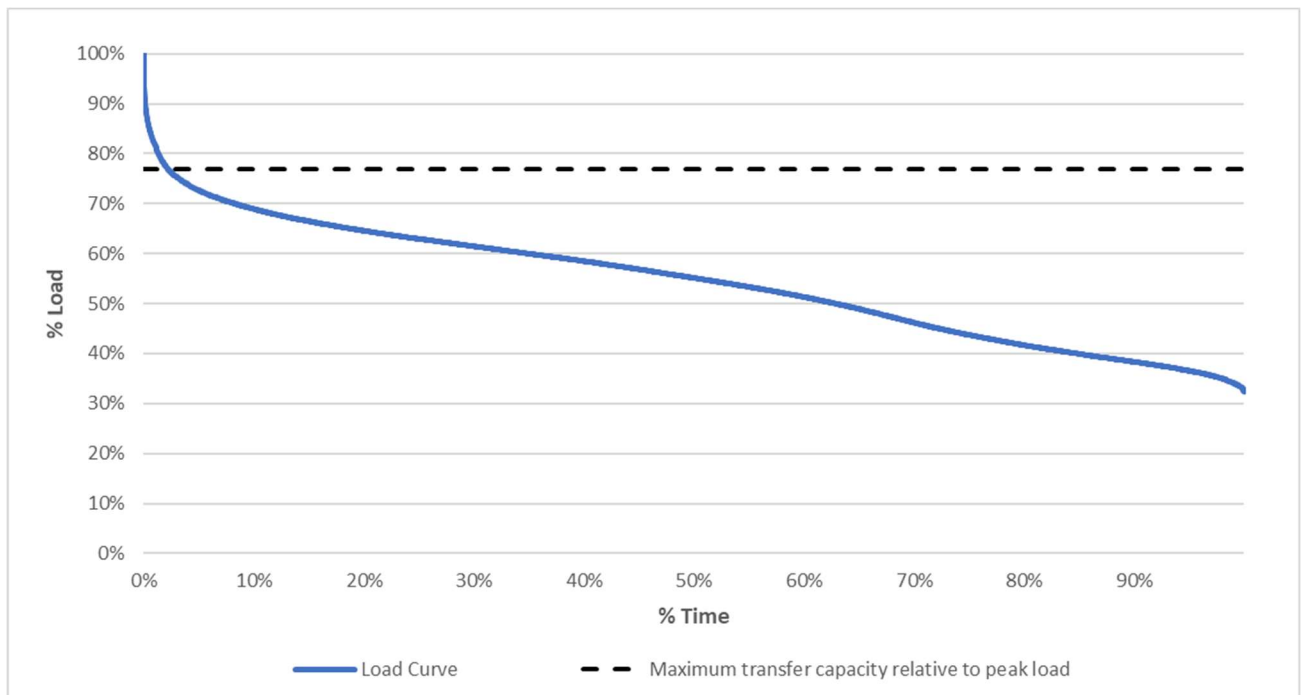

D.2 Supply restoration assumptions

Table D.2 – Supply restoration assumptions

Equipment outage	Action	Outage duration
Fluid filled cable failure	<u>Repair</u> The cable is repaired on site.	6.0 weeks
XLPE cable failure	<u>Repair</u> The cable is repaired on site.	2.0 weeks
Fluid filled cable third party damage	<u>Repair</u> The cable is repaired on site. Additional time is typically required to repair third party damage.	5.5 weeks
Fluid filled cable corrective action	<u>Repair</u> One of the following repairs may take place depending on the failure mode: 1. in service repair (80 per cent) 2. out of service repair (20 per cent)	1. In service repair (no outage) 2. 1.06 weeks

D.3 Probability of failure

Ausgrid has adopted probability models to estimate expected failure of different network assets. A summary of the models adopted and the key parameters used are summarised in the table below.

Table D.3 – Summary of failure probability models used to estimate failure probability

Network asset type	Failure probability model	Key parameters
Underground cables	Crow-AMSAA model	Cumulative number of failures per km Age of cable at failure in years Measure of the failure rate

Underground cables

The Crow-AMSAA model is used to determine the probability of failure and unavailability for underground cables. Crow-AMSAA models are fitted for fluid filled, HSL and XLPE cables.

The Crow-AMSAA model can be used to evaluate probability of failure for repairable systems. As a result, it can be used to model a cable section that has failed and has been repaired multiple times over its lifetime. The model is also capable of handling a mixture of failure modes. Events affecting Ausgrid's underground sub-transmission cables are classified as corrective action, failure or third-party damage.

An analysis is undertaken of failure data to ascertain the age of the cable at the time of each event. A log-log plot of cumulative failures (per km) versus cumulative time (i.e. age in years) is produced and a line of best fit determined. The resulting log-log plot is linear and the line of best fit can be described by Equation 1.

Equation 1

$$z(T) = \lambda\beta T^{\beta-1}$$

where:

$z(T)$ is the current failure intensity at time T (normalised per km length)

- T is the cumulative time (i.e. age of the cable at failure, in years)
- β is the shape parameter
- λ is a scale parameter

The above process is carried out for corrective actions, failures and third party damage for fluid filled cables. Table D.3 shows the modelled Crow-AMSAA parameters for each cable type.

Table D.4 – Underground cable parameters

Feeder	Type	B factor	Λ factor	MTTR ¹³ (weeks)
9SA (oil portion)	Corrective action	6.396	5.82E-11	1.06
9SA (oil portion)	Breakdowns	6.014	1.83E-12	6.00
9SA (oil portion)	Third party damage	1.00	2.91E-02	5.50
9SA (XLPE portion)*	Breakdowns	0.24	0.02	2.00
92P (oil portion)	Corrective action	6.455	5.82E-11	1.06
92P (oil portion)	Breakdowns	6.069	1.83E-12	6.00
92P (oil portion)	Third party damage	1.00	2.91E-02	5.50
92P (XLPE portion)*	Breakdowns	0.24	0.02	2.00
260	Corrective action	6.323	5.82E-11	1.06
260	Breakdowns	5.945	1.83E-12	6.00
260	Third party damage	1.00	2.91E-02	5.50
261	Corrective action	6.32	5.82E-11	1.06
261	Breakdowns	5.942	1.83E-12	6.00
261	Third party damage	1.00	2.91E-02	5.50

* Feeders 9SA and 92P have been partially replaced with new XLPE portions.

* XLPE cables do not have corrective actions as they are not fluid filled.

* There is insufficient data on third party damage of XLPE cables to develop Crow-AMSAA parameters.

The frequency of corrective action, failure or third party damage can then be determined by applying Equation 2 to each cable section.

Equation 2

$$f = L\lambda((T + 1)^\beta - T^\beta)$$

Where:

- f is the frequency of failures
- L is the length of the cable segment (km)

Failures and third party damage result in cables being taken out of service. Corrective actions do not typically result in cables being taken out of service. Equation 3 shows how the frequency is used to calculate unavailability for failures or third party damage.

Equation 3

$$U = \frac{f \times MTTR_{weeks}}{52 + f \times MTTR_{weeks}}$$

¹³ Mean Time To Repair

The total cable section unavailability is calculated taking the union of the failure and third-party damage unavailabilities as shown in Equation 4. If a feeder consists of multiple cable sections, the feeder unavailability is calculated by taking the union of all the respective section unavailabilities

Equation 4

$$U_{total} = U_{failure} \cup U_{TPD}$$

Figure 2.2 in section 2.3.2 shows unavailability plotted on a logarithmic scale when the above equations are applied to 10km cables aged 0 – 100 years. This model is also based on the assumption that the condition of a cable is dependent upon its age. The Crow-AMSAA model shows that the availability of fluid filled cables is expected to decline if the cables are retained past an age of 50.

D.4 Environmental costs

Ausgrid has experienced major leaks from SCFF cables and some Ausgrid cables leak smaller amounts of oil into the environment that are difficult to locate and repair. Ausgrid policy is to minimise environmental impact to the extent it is practical. Regardless, fluid leaks expose Ausgrid to a risk of liability under the Protection of the Environment Operations Act 1997 (NSW), particularly in relation to pollution of water and pollution of land. It is necessary to include the environmental risk in the cost benefit analysis as the continued service of SCFF cables will result in further deterioration in condition and an increasing number of failures that are random in nature. These failures have the potential to cause damage to the environment. The quantification of environmental risk is calculated as follows.

Equation 5

$$Environmental\ risk\ cost = F \times EC \times \beta$$

Where;

F is the failure rate of the equipment

EC is the environmental criticality of the failure mode

β is a factor calculated based on the conditional probability of ground water impacts from a fluid leak of the feeder (based on the length of feeder in waterways)

The Environmental Criticality (EC) is calculated for the three feeder failure types described in Table D.1, namely;

- corrective actions;
- breakdowns; and
- third party damage.

Each failure type is made up by a group of possible failure modes. For each failure type, the Mean Time To Repair is determined by taking the average of the repair times for each failure mode assuming equal likelihood for each failure mode within that failure type. The proportion of the year that would be impacted by a single equivalent failure is then used to weight the monetised consequence of a significant fluid leak to produce the Environmental Criticality for each failure type.

Equation 6

$$Environmental\ Criticality = \frac{MTTR}{52} \times Sig.\ oil\ leak\ cost$$

Where;

$MTTR$ is the Mean Time To Repair in weeks

Sig. oil leak cost is the monetised worth of a detectable fluid leak of 5L per day for one year multiplied by \$3,000/L¹⁴ (5L x 365 days x \$3,000 = \$5.475M) plus an amount of \$10,446 being a weighted tier two and/or three fine under the POEO Act.

Table D.5: Environmental Criticality for each failure type

Factor Description	Corrective Action	Breakdown	Third Party Damage
Environmental Criticality	\$111,883	\$632,936	\$580,191
9SA Conditional probability of ground water impact (β)	0.0694	0.2	0.1319
92P Conditional probability of ground water impact (β)	0.0694	0.2	0.1319
260 Conditional probability of ground water impact (β)	0.1221	0.3517	0.2320
261 Conditional probability of ground water impact (β)	0.1119	0.3224	0.2126

D.5 Direct costs of rquipment failures

In the event of a serious failure of a fluid filled cable, repairs would need to be done to return the cable into service. As this cost is avoided if the cable is replaced before any failure takes place, this repair cost represents a saving and is factored into the cost benefit analysis. The following equation is used to calculate the impact of repair cost.

Equation 7

$$\text{Repair cost} = F \times D$$

Where;

F is the failure rate

D is the repair cost per event

D.6 Calculation of central VCR estimate for Zetland ZS

Table D.6 – Breakdown of the central VCR estimate for the Zetland ZS

	Unit	Residential	Small non-residential	Large non-residential (LV)	Large non-residential (HV)
Annual consumption	MWh	67,293	51,883	121,007	25,518
Per cent of annual consumption	%	25.3%	19.5%	45.5%	9.6%
2021 AER VCR estimate	\$/kWh	\$30.37	\$70.84	\$66.16	65.20
Load-weighted VCR for Zetland:	\$/kWh				
- 2021		\$57.92			
- June 2022 (adjusted by June CPI)		\$61.01			

¹⁴ NSW EPA's Regulatory Impact Statement – Proposed Protection of the Environment Operations (Underground Petroleum Storage Systems) Regulation 2014 – states "Petroleum can contaminate large volumes of groundwater. For example, according to Environment Canada, one litre of gasoline can contaminate 1,000,000 litres of groundwater. If water used for domestic purposes is priced at about \$3,000/ML (Deloitte Access Economics 2013)..."

The underpinning assumptions for the calculation of the VCR for Zetland ZS are:

- For residential loads, the VCR is determined by using the postcode of the area (i.e. Waterloo, NSW, 2017), which is located under Climate Zone 5 CBD & Suburban NSW, as determined by the AER¹⁵ and adjusted by CPI.
- Small non-residential loads are considered to be small businesses, for which the VCR determined by the AER¹⁶ for commercial small-medium businesses is applied, adjusted by CPI.
- Large non-residential Low Voltage (LV) loads are predominantly industrial loads in this area. For this reason, the VCR calculated for average industrial loads¹⁷ is applied, adjusted by CPI.
- Large non-residential High Voltage (HV) loads are considered to be large industrial businesses, for which the VCR calculated for industrial large businesses¹⁷ is applied, adjusted by CPI.

¹⁵ See [AER, Annual update – VCR review final decision – Appendix F – Residential VCR by postcode, December 2021](#).

¹⁶ See [AER, Annual update – VCR review final decision – Appendices A-E – Final decision – Adjusted values, December 2021](#).

